

USER'S MANUAL

MODEL MDM60001

MICROSTEP DRIVER

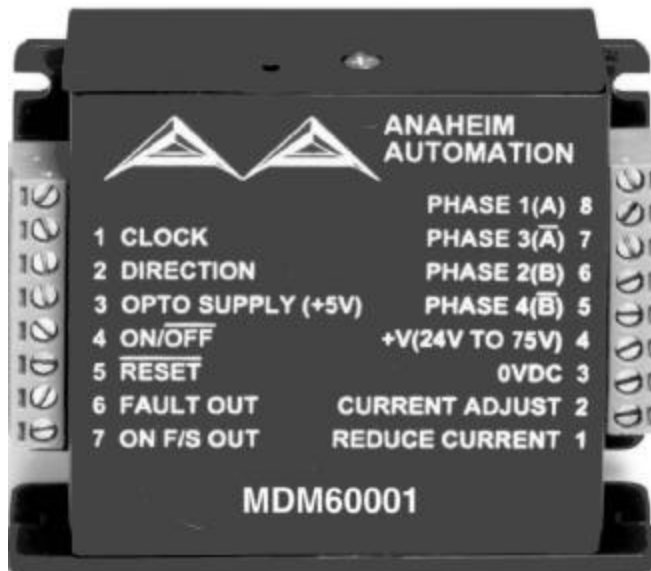

ANAHEIM AUTOMATION
910 E. Orangefair Lane
Anaheim, CA 92801
TEL (714) 992-6990
FAX (714) 992-0471
<http://members.aol.com/aamotion/>
e-mail: aamotion@aol.com

COPYRIGHT

Copyright 1996 by Anaheim Automation. All rights reserved. No part of this publication may be reproduced, transmitted, transcribed, stored in a retrieval system, or translated into any language, in any form or by any means, electronic, mechanical, magnetic, optical, chemical, manual, or otherwise, without the prior written permission of Anaheim Automation, 910 E. Orangefair Lane, Anaheim, CA 92801.

DISCLAIMER

Though every effort has been made to supply complete and accurate information in this manual, the contents are subject to change without notice or obligation to inform the buyer. In no event will Anaheim Automation be liable for direct, indirect, special, incidental, or consequential damages arising out of the use or inability to use the product or documentation.

Anaheim Automation's general policy does not recommend the use of its products in life support applications wherein a failure or malfunction of the product may directly threaten life or injury. Per Anaheim Automation's Terms and Conditions of Sales, the user of Anaheim Automation products in life support applications assumes all risks of such use and indemnifies Anaheim Automation against all damages.

LIMITED WARRANTY

All Anaheim Automation products are warranted against defects in workmanship, materials and construction, when used under Normal Operating Conditions and when used in accordance with specifications. This warranty shall be in effect for a period of twelve months from the date of purchase or eighteen months from the date of manufacture, whichever comes first. Warranty provisions may be voided if the products are subjected to physical damage or abuse.

Anaheim Automation will repair or replace at its option, any of its products which have been found to be defective and are within the warranty period, provided that the item is shipped freight prepaid, with RMA (return material authorization), to Anaheim Automation's plant in Anaheim, California.

TECHNICAL SUPPORT

Everyone needs help on occasion. If you have problems using any of the equipment covered by this manual, please read the manual to see if it will answer the questions you have. If you need assistance beyond what this manual can provide, you can call your Local Distributor where you purchased the unit.

TABLE OF CONTENTS

	PAGE
INTRODUCTION	2
ORDERING INFORMATION	3
DESCRIPTION	4
DRIVER TERMINAL DESCRIPTION P1	4
DRIVER TERMINAL DESCRIPTION P2	5
WIRING DIAGRAM	6
SPECIFICATIONS	7
OUTPUT CURRENT	8
DETERMINING OUTPUT CURRENT	8
SETTING OUTPUT CURRENT	8
REDUCING OUTPUT CURRENT	9
MOTOR SELECTION	9
STEP MOTOR CONFIGURATION	10
STEP MOTOR CONNECTION	12
POWER CONNECTIONS	12
ANAHEIM AUTOMATION STEP MOTOR SELECTION	13
MICROSTEP SELECTION	14
FULLSTEP OUTPUT SIGNAL	15
OPTICALLY ISOLATED INPUTS	15
TIMING	16
FAULT PROTECTION	17
TORQUE/SPEED CURVES	18

INTRODUCTION

The MDM60001 is a High Performance, low cost microstepping driver that incorporates advanced surface mount and ASIC technology. The MDM60001 is compact, easy to interface, and powerful enough to handle the most demanding applications. Anaheim Automation recognizes that cost and size are important criteria in many low and medium power applications. The MDM60001 was designed to meet those needs and offers innovative features.

The MDM60001 will deliver a peak current of 6 Amperes per phase at 75 Volts, providing outstanding motor performance. This advanced technology reduces ripple current while maintaining the 20kHz chopping frequency in the motor, causing less heat in both the motor and drive. In many cases, no special or additional heatsink is required.

With the MDM60001, various step resolutions can be implemented by the on-board dip switches. These divisions range from 400 steps per revolution to 51,200 steps per revolution, and are available in both binary and decimal numbers. The bipolar drive configuration handles 4, 6, and 8 lead motors. Protection devices have been added to this driver for *All-Way-Short-Circuit*, *Over/Under Voltage*, and *Excessive-Temperature* conditions. If an error (short-circuit or excessive-temperature) occurs, a 'Fault Output' can be used to inform the machine control of a problem. An 'At Full Step' output enables the control to know when the motor is positioned in one of the natural step angles of the motor (typically every 1.8°).

Driver features include:

- Low Cost
- Small Size (3.4"x 3.0"x 1.375")
- Input Voltage 24 to 75VDC
- Output Current 6 Amps Peak
- 400 to 51,200 steps/rev
- Short Circuit Protection
- Excessive-Temperature Protection
- No Minimum Inductance
- Optical Isolation
- Fault Output

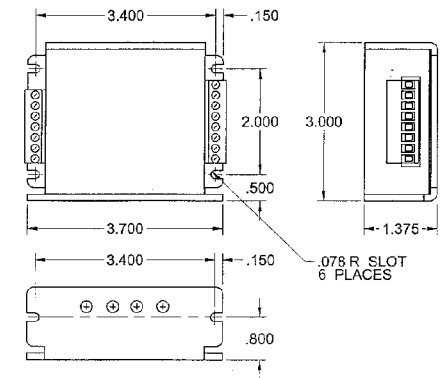

**ORDERING INFORMATION FOR ANAHEIM AUTOMATION
MICROSTEP DRIVERS AND ACCESSORIES**

4 Amp Microstep Driver	MDM40001
6 Amp Microstep Driver	MDM60001 (This Manual)
10 Amp Microstep Driver	MDM10001
40VDC Power Supply	PSA40V4A (For MDM40001)
40VDC Power Supply	PSA40V8A-2 (For MDM40001)
	Includes +5Vdc Supply
65VDC Power Supply	PSA65V5A (For MDM60001)
65VDC Power Supply	PSA65V5A-2 (For MDM60001)
	Includes +5Vdc Supply
80VDC Power Supply	PSA80V4A (For MDM10001)
Shielded Motor Cable	AA129010S

MDM40001

This is the model number for a Single Axis, 4 Amp Microstep Driver. The MDM40001 requires a dc power supply (up to 48 volts).

MDM60001

This is the model number for a Single Axis, 6 Amp Microstep Driver. MDM60001 requires a 65Vdc power supply (PSA65V5A-2) that Anaheim Automation provides, purchased separately.

MDM10001

This is the model number for a Single Axis, 10 Amp Microstep Driver. The MDM10001 requires an 80Vdc power supply (PSA80V4A) that Anaheim Automation provides, purchased separately.

PSA40V4A

This is an unregulated 40VDC, 4 Amp power supply.

PSA65V5A

This is an unregulated 65VDC, 5 Amp power supply.

PSA80V4A

This is an unregulated 80VDC, 4 Amp power supply.

PIN DESCRIPTIONS P1

Pin#	Description
1	Clock: A positive going edge on this isolated input advances the motor one increment. The size of the increment is dependent on the Microstep Select Inputs of Switch 1.
2	Direction: This isolated input is used to change the direction of the motor. Physical direction also depends on the connection of the motor windings.
3	Opto Supply (+5VDC): This input is used to supply current to the Isolated Inputs. A higher voltage may be used, but care should be taken to limit the current through the optocoupler.
4	On/Off: This isolated input is used to enable/disable the output section of the driver. When HIGH (open) the outputs are enabled. However, this input does not inhibit the step clock. Therefore the outputs will be updated by the number of clock pulses (if any) applied to the driver while it had been disabled.
5	Reset: When LOW, this isolated input will reset the driver (outputs will disable). When released, the driver will be at its initial state (Phase 1&3 off, Phase 2&4 full on).
6	Fault Out: This OPEN DRAIN output indicates a fault has occurred (ie. short circuit or over temperature). This output is active low.
7	On F/S Out: This OPEN DRAIN output indicates when the driver is positioned at a full step. This output can be used to count the number of full steps the motor has moved, regardless of the number of microsteps in between. This output is active low.

Table 1 - CONNECTOR P1

PIN DESCRIPTIONS P2

Pin#	Description
1	Reduce Current: Phase Current Reduction Input. A resistor between this pin and pin 2 (Connector P2, Current Adjust) will proportionately reduced the current in both windings (1 second after the last positive going edge of the step clock input). The amount of current reduction will depend on the value of the resistor used.
2	Current Adjust: Phase Current Adjustment input. A resistor connected between this input and the ground input (connector P2, Pin 3) is used to adjust the maximum Phase Current in the motor. A resistor MUST be connected to this input.
3	0VDC: Supply Voltage Ground. (Return)
4	+V: Supply Voltage Input. (+24 -75VDC)
5	Phase 4: of the Step Motor
6	Phase 2: of the Step Motor
7	Phase 3: of the Step Motor
8	Phase 1: of the Step Motor

Table 2 - CONNECTOR P2

TYPICAL HOOK-UPS FOR APPLICATION:

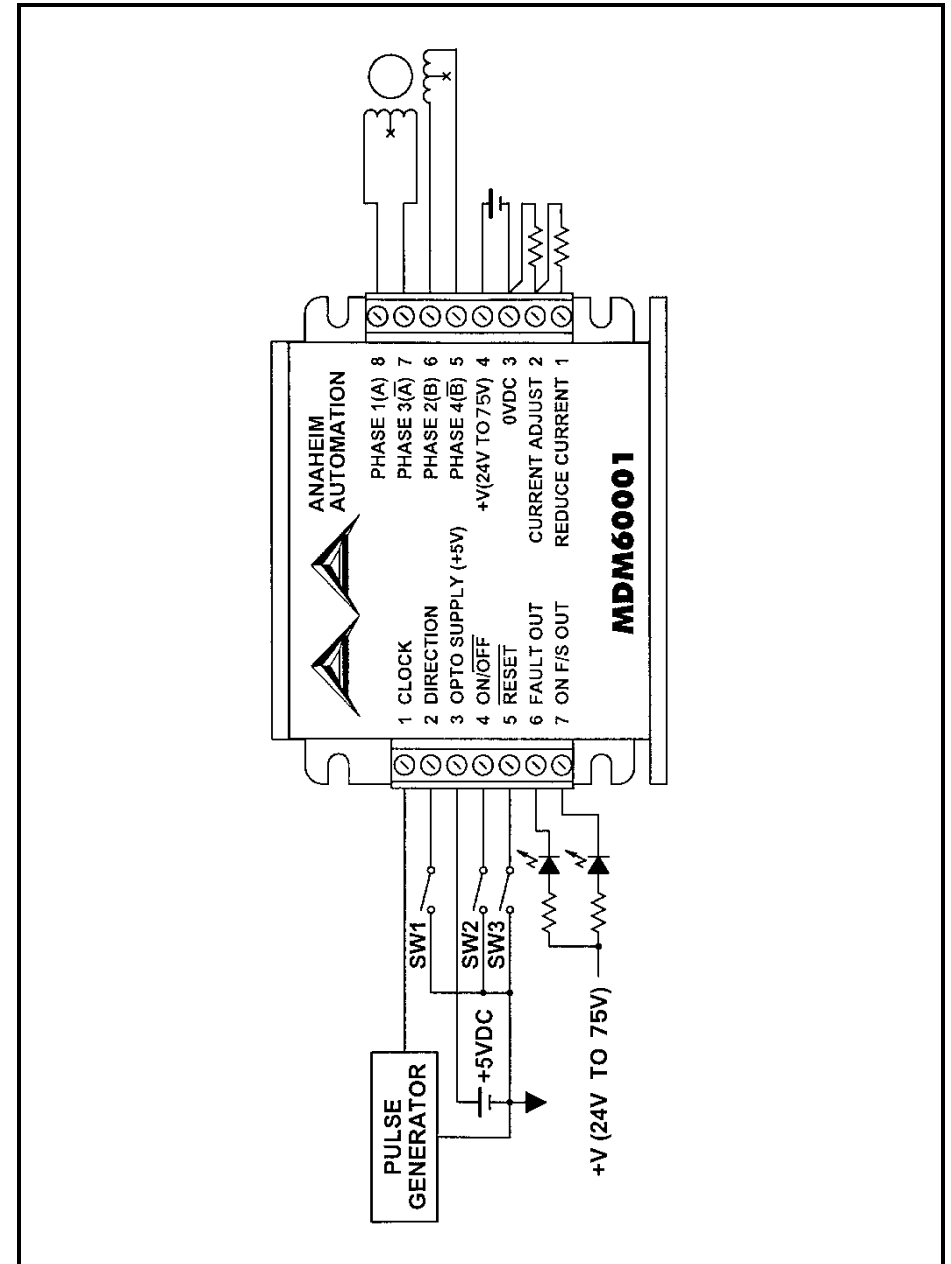

FIGURE 1

SPECIFICATIONS

ABSOLUTE MAXIMUM RATINGS

INPUT VOLTAGE	+24 TO +75 VDC
OUTPUT CURRENT	6 AMPS PEAK
PLATE TEMPERATURE	70° C
STORAGE TEMPERATURE	40° TO +125° C
INPUT CURRENT (PINS 1, 2, 4, 5)	15 mA Max

ELECTRICAL SPECIFICATIONS (TA=25°C, V+ = 75VDC)

ITEM	TEST CONDITION	MIN	TYP	MAX	UNIT S
Input Voltage		24		75	V
Phase Output Current	RMS	1		4	A
Phase Output Current	Peak	1.4		6	A
Quiescent Current	Outputs Floating			13	mA
Active Power Dissipation	Iout=4 Amps RMS			9	W
Input Forward Current	Input Pins 1, 2, 4, 5		7	15	mA
Input Forward Voltage			1.4	1.7	V
Input Reverse Breakdown Voltage		5			V
Output Current	Fault, Fullstep Outputs			25	mA
Collector-Emitter Voltage	Fault Output			140	V
Collector-Emitter Saturation Voltage	Fault Output Ics=25mA DC			0.2	V
Drain-Source Voltage	Fullstep Output			100	V
Drain-Source on Resistance	Fullstep Output Ics=25mA DC		6.5		ohms

DETERMINING OUTPUT CURRENT

The output current for the motor used when microstepping is determined differently from that of a halfstep/fullstep unipolar driver. In the MDM60001, a sine/cosine output current is used in rotating the motor. The output current for a given motor is determined by the motors current rating *and* the configuration for how the motor is hooked up. There is a current adjustment resistor used to set the output current of the MDM60001. This sets the peak output current of the sine/cosine waves. The specified motor current (which is the RMS value) is multiplied by a factor of 0.7, 1.0, or 1.4 depending on the motor configuration (half-coil, series, or parallel).

SETTING OUTPUT CURRENT

The output current on the MDM60001 is set by an external ±1%, 1/8 watt (or higher) resistor between pins 2 and 3 of connector P2. This resistor determines the per Phase RMS output current of the driver. The MDM60001 uses a 2mA current source to establish the reference voltage needed to control the output current. The relationship between the output current and the resistor value is as follows:

$$\text{RMS OUTPUT CURRENT (Amps)} = (.707)(0.002)(\text{Resistor in Ohms})$$

RMS Current	Resistor Value	RMS Current	Resistor Value
1.0	698	2.5	1740
1.2	845	2.6	1820
1.4	988	2.7	1890
1.6	1110	2.9	2030
1.7	1180	3.0	2100
1.9	1330	3.2	2230
2.0	1400	3.3	2320
2.2	1540	3.4	2370
2.3	1600	3.8	2670
2.4	1670	4.0	2870

TABLE 3: RESISTOR VALUES WITH RESPECT TO OUTPUT CURRENT

Closest 1% value selected

WARNING! A current adjustment resistor is always necessary to keep the drive in a safe operating region. Do not operate the driver without a current adjustment resistor. When connecting the CURRENT ADJUSTMENT resistor between Pins 3 and 2 of Connector P2 the length of the leads should be as short as possible to help minimize the noise coupled into the driver. Refer to Figure 1 for TYPICAL HOOK-UP.

REDUCING OUTPUT CURRENT

Reducing the output current in the MDM60001 can be accomplished by connecting an external resistor (1/8 watt or higher) between pins 1 and 2 of connector P2 and occurs automatically 1 second after the last positive going edge of the step clock input. See Figure 1 for TYPICAL HOOK-UP.

The amount of current per Phase in the reduction mode is related to the value of the current adjustment resistor and the current reduction resistor. When the current reduction circuit is activated, the current reduction resistor is paralleled with the current adjustment resistor. This lowers the total resistance value, and thus lowers the per Phase output current. The relationship between the output current and the resistor's value is as follows:

$$\text{RMS Reduction Current (Amps)} = \frac{(.707)(.002) \times R(\text{Adjust}) \times R(\text{Reduction})}{R(\text{Adjust}) + R(\text{Reduction})}$$

NOTE: When connecting the current reduction resistor between pins 1 and 2 of connector P2, the length of the leads should be as short as possible to help minimize noise coupled into the driver.

MOTOR SELECTION

The MDM60001 is a Bipolar driver working equally well with both Bipolar and Unipolar Motor Configurations, (i.e. 8 and 4 lead motors and 6 lead center tapped motors).

Motors with low current ratings and high inductance will perform better at low speeds, providing higher low-end torque. Motors with high current ratings and low inductance will perform better at higher speeds, providing higher high-end torque.

Since the MDM60001 is a constant current source, it is not necessary to use a motor that is rated at the same voltage as the supply voltage. What is important is that the MDM60001 is set to the appropriate current level based on the motor being used.

Higher voltages will cause the current to flow faster through the motor coils. This in turn means higher step rates can be achieved. *Care should be taken not to exceed the maximum voltage of the driver.*

STEP MOTOR CONFIGURATIONS

Step motors can be configured as 4, 6, or 8 leads. Each configuration requires different currents. Shown below are different lead configurations and the procedures to determine their output current.

6 Lead Motors

When configuring a 6 lead motor in a **half-coil configuration** (connected from one end of the coil to the center tap) use the specified per Phase (or unipolar) current rating to determine the current adjustment resistor value. This configuration will provide more torque at higher speeds. Use this to determine the current adjustment resistor value.

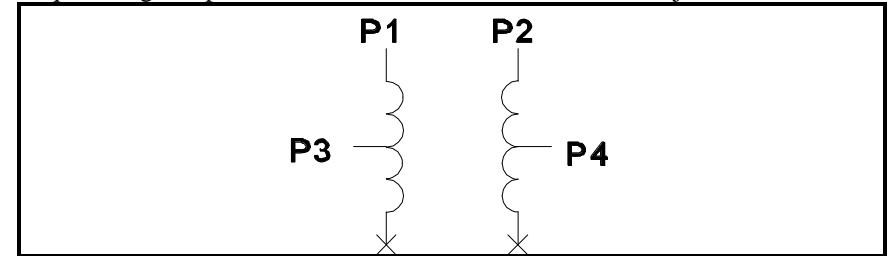

When configuring the motor in a **series configuration** (connected from end to end with the center tap floating) multiply the per Phase (or unipolar) current rating by 0.7. Use this result to determine the current adjustment resistor value.

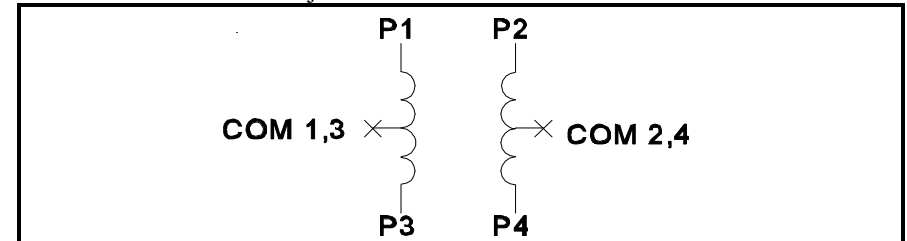

WARNING! Step motors will run hot even when configured correctly, damage may occur to the motor if a higher than specified current is used. Most specified motor currents are maximum values. Care should be taken to not exceed these ratings.

4 Lead Motors

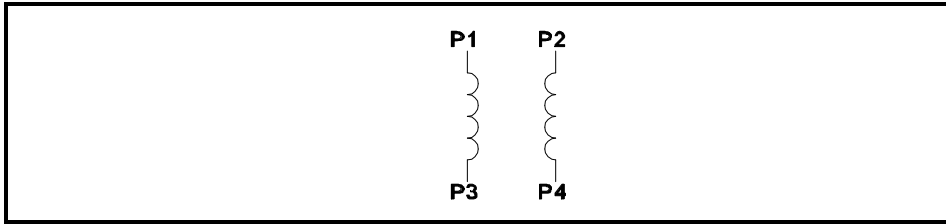

Use the specified *series* motor current to determine the current adjustment resistor value. Four Lead Motors are usually rated with their appropriate series current, as opposed to the *Phase Current* which is the rating for 6 and 8 lead motors.

8 Lead Motors

Series Connection: When configuring the motor windings in series, multiply the per Phase (or unipolar) current rating by 0.7. Use this result to determine the current adjustment resistor value.

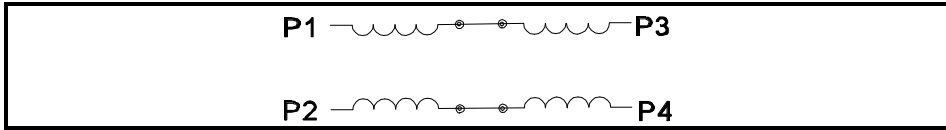

Parallel Connection: When configuring the motor windings in parallel, multiply the per Phase (or unipolar) current rating by 1.4. Use this result to determine the current adjustment resistor value.

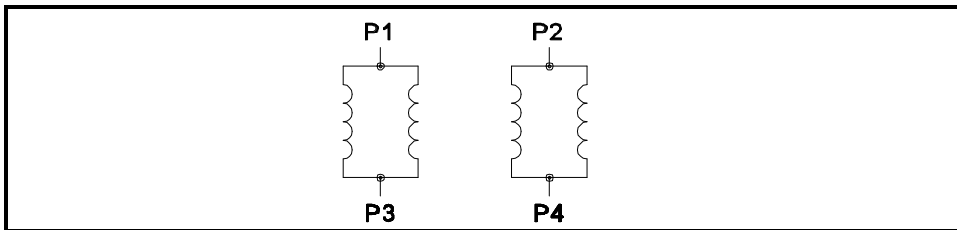

NOTE: After the current has been determined, according to the motor connections above, follow the procedure Determining Output Current above to find the current value. Then use Table 3 to choose the proper resistor value.

CONNECTING THE STEP MOTOR

Phase 1&3 of the Step Motor is connected between pins 7 and 8 on connector P2. Phase 2&4 of the Step Motor is connected between pins 5 and 6 on connector P2.

Refer to Figure 1 for TYPICAL APPLICATION HOOK-UP

NOTE: The physical direction of the motor with respect to the direction input will depend on the connection of the motor windings. To reverse the direction of the motor with respect to the direction input, switch the wires on Phase 1 & Phase 3.

WARNING: Do not connect or disconnect motor wires while power is applied!

CONNECTING POWER

Pins 3 and 4 on connector P2 are used to connect the DC Power Supply to the MDM60001. *Wire size used to connect the power source to the driver should be at least 16 gauge.* Heavier wire should be used for longer distances between the power supply and the driver. The power supply requirements are as follows:

Switching Power Supplies and regulated linears with overcurrent protection are not recommended because of their inability to handle surge currents. Adding a capacitor to the output will alleviate this problem.

When multiple drivers are run from one power supply, each driver should have separate power and ground wires that connect directly to the output capacitor of the power supply. Refer to Figure 1 for TYPICAL APPLICATION HOOK-UP.

WARNING: When using an unregulated power supply, care should be taken to ensure that the output voltage DOES NOT exceed the maximum driver input voltage because of line voltage fluctuations. It is recommended that an input line filter be used on the power supply to limit voltage spikes to the driver.

Anaheim Automation Step Motor Selection Guide

Part Number suffix: single shaft - "S" dual shaft - "D"	Motor Current (Unipolar Rating) [Amps]	Series Configuration 1% Resistor Value [Ohms]
23D104	2.0	1000
23D108	3.9	1960
23D204	1.8	909
23D209	4.7	2370
23D306	2.9	1450
23D309	4.6	2320
34D106	3.0	1500
34D109	4.8	2400
34D207	3.5	1760
34D209	4.6	2320
34D307	3.5	1760
34D311	5.5	2770
34D314	7.0	2870

TABLE 4: Resistor Table Selection is based on 6-Lead Step Motors
Series Coil Configurations.

MICROSTEP SELECTION

The number of microsteps per step is selected by the internal dip switches. Table 5 shows the standard resolution values along with the associated settings for these switches. The standard waveforms are sinusoidal.

Resolution	Steps/Rev	Switch 1	Switch 2	Switch 3	Switch 4
2	400	ON	ON	ON	ON
4	800	OFF	ON	ON	ON
8	1,600	ON	OFF	ON	ON
16	3,200	OFF	OFF	ON	ON
32	6,400	ON	ON	OFF	ON
64	12,800	OFF	ON	OFF	ON
128	25,600	ON	OFF	OFF	ON
256	51,200	OFF	OFF	OFF	ON
5	1,000	ON	ON	ON	OFF
10	2,000	OFF	ON	ON	OFF
25	5,000	ON	OFF	ON	OFF
50	10,000	OFF	OFF	ON	OFF
125	25,000	ON	ON	OFF	OFF
250	50,000	OFF	ON	OFF	Open

TABLE 5

In order to select the microstepping switches, the top cover plate of the driver must be removed. The dip switch is located on the upper left hand corner as show on the drawing to the right.

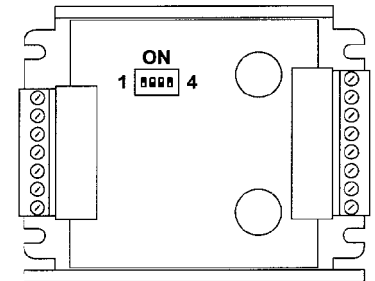

FULLSTEP OUTPUT SIGNAL

The MDM60001 has an active LOW open drain output at Connector P1, Pin 7 labeled ON F/S OUT. This output is TRUE (active low) for the duration of the full step. A full step occurs when either Phase 1&3 or Phase 2&4 cross through zero (ie. full current in one winding and 0 current in the other winding). This full step position is a common position no matter what resolution is selected.

This output can be used to count the number of mechanical full steps the motor has traveled without having to count the number of microsteps in between. A controller that utilizes this output can greatly reduce its position tracking overhead and thus substantially increase its throughput.

This high speed MOSFET output is non-isolated and has the ability to sustain the maximum driver voltage at 25mA maximum.

OPTICALLY ISOLATED INPUTS

The following inputs to the MDM60001 are Optically Isolated.

Item	Pin #
Clock	1
Direction	2
On/Off	4
Reset	5

WARNING! If using a voltage other than +5VDC, the current through the optocoupler must NOT exceed the maximum limit.

The Isolated inputs may be powered by a DC voltage other than +5 VDC. In doing so, care should be taken to limit this current, an external resistor should be placed in series with the input pins (1-2, 4-5). The value of the resistor should be calculated such that the input current is approximately equal to the value listed in the Electrical Specifications.

TIMING

The Direction and Microstep Resolution Select inputs are synchronized with the positive going edge of the Step Clock input. When the Step Clock input goes high, the Direction and Microstep Select inputs are latched and further changes to the inputs are ignored until the next rising edge of the Step Clock input.

After these signals are latched, the MDM60001 looks to see if any changes have occurred to the Direction and the Microstep Select inputs. If a change has occurred, the MDM60001 will execute the change before taking the next step. Only AFTER the change has been executed will the step be taken. If no change has occurred the MDM60001 will simply take the next step. This feature works as an automatic debounce for the Direction and Microstep Select inputs.

The minimum pulse width for the Clock input is 75 nS. The typical execution time for a Direction or Microstep Select change is 100nS. The typical execution time for a Clock input is 100nS.

The Reset and Enable inputs are asynchronous to any input and can be changed at any time.

The Reset requires a minimum pulse width of 500 nS.

The Fullstep output typically occurs 75nS after the positive edge of the Step Clock (excluding changes to the Direction or the Microstep Select inputs).

FAULT PROTECTION

The MDM60001 is internally protected against over temperature, over/under voltage, and short circuits.

The over temperature set point is between 60°C and 70°C. *Care should be taken when choosing a heatsink so that there is good thermal flow, otherwise hot spots may occur in the MDM60001 which will reduce the effectiveness of the thermal protection.*

The short circuit protection consists of PHASE to PHASE, PHASE to GROUND, and +V to PHASE.

In the condition where the DC voltage of the driver drops below +23 volts the driver's output stage will be disabled. When the driver's DC voltage rises back above 24 volts, the driver will automatically re-enable the outputs (if previously enabled).

In the condition where the DC voltage of the driver exceeds approximately 82 volts, the driver will execute a fault.

If any fault is detected by the MDM60001, the outputs will be disabled and can not be re-enabled without resetting or powering down the driver. At the same time the open collector FAULT output is turned on.

The FAULT output is non-isolated and has the ability to sustain the maximum driver voltage. It is capable of sinking up to 25mA which can be used to drive a small relay or LED.

OVER TEMPERATURE PROTECTION

The MDM60001 microstepper is a power device and is designed to protect itself from overheating. It does this by monitoring the surface temperature of the drive plate and will automatically shutdown if the temperature reaches 60°C (152°F).

To prevent nuisance shutdowns, proper heatsinking is required to limit the temperature at the drive plate.

A thermal grease or thermal pad should be used between the drive plate and the mounting surface of the heatsink. The fins of the heatsink should be mounted vertically with at least 3" of space below and above the heatsink for efficient cooling.

In some applications fan cooling will be required to maintain the plate temperature below the 60°C shutdown temperature.

TORQUE/SPEED CURVES

23D102 (SERIES)
DIVIDE BY 10, CURRENT=1.0A, R=484

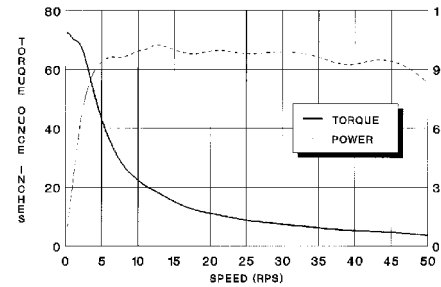

23D104 (SERIES)
DIVIDE BY 10, CURRENT=2.0A, R=1K

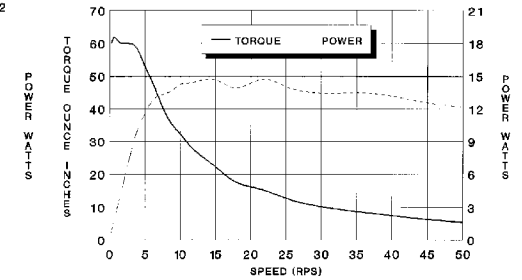

23D108 (SERIES)
DIVIDE BY 10, CURRENT=3.9A, R=2K

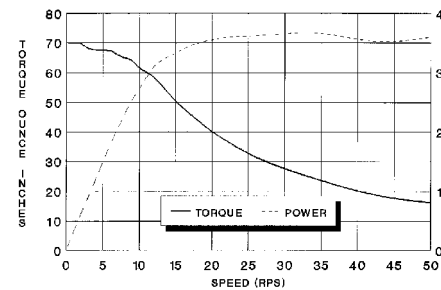

23D204 (SERIES)
DIVIDE BY 10, CURRENT=1.8A, R=845

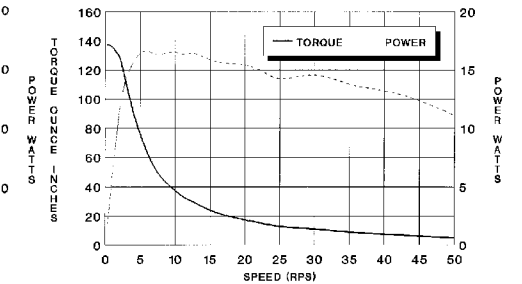

23D209 (SERIES)
DIVIDE BY 10, CURRENT=4.7A, R=2K

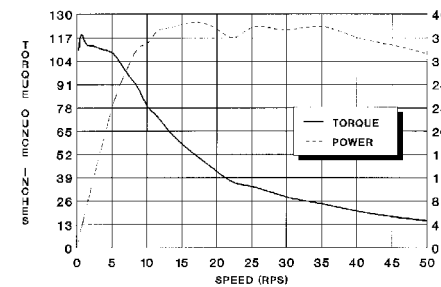

23D306 (SERIES)
DIVIDE BY 10, CURRENT=2.9A, R=1.4K

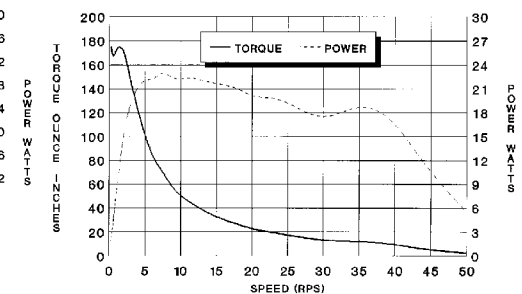

Notes:

TORQUE/SPEED CURVES

23D309 (SERIES)
DIVIDE BY 10, CURRENT=4.6A, R=1.69K

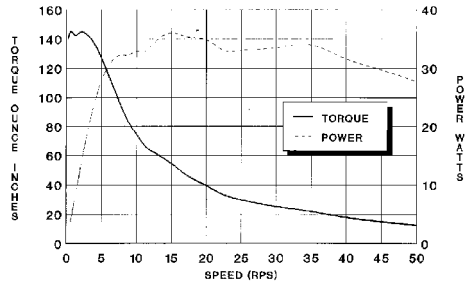

34D106 (SERIES)
DIVIDE BY 10, CURRENT=3.0A, R=1.47K

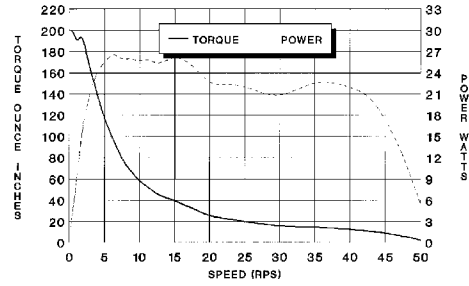

34D109 (SERIES)
DIVIDE BY 10, CURRENT=4.8A, R=2K

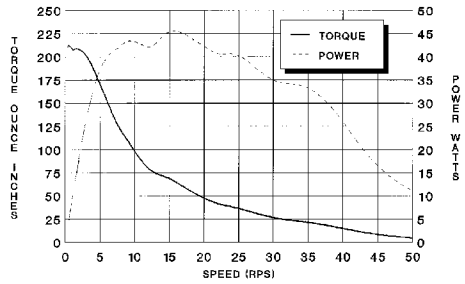

34D207 (SERIES)
DIVIDE BY 10, CURRENT=4.6A, R=1.82K

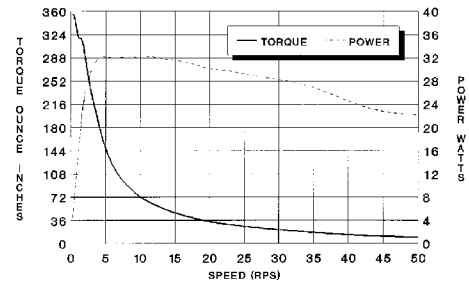

34D209 (SERIES)
DIVIDE BY 10, CURRENT=4.6A, R=2K

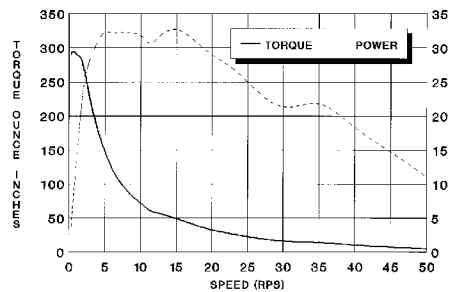

34D307S
DIVIDE BY 10, CURRENT=3.5A, R=1.82K

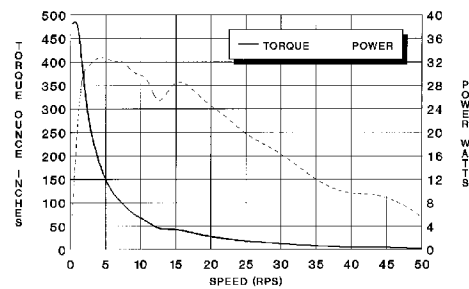

Notes:

ANAHEIM AUTOMATION